

POWER SOURCE

AC Terminal Cover for NDR-240 Series

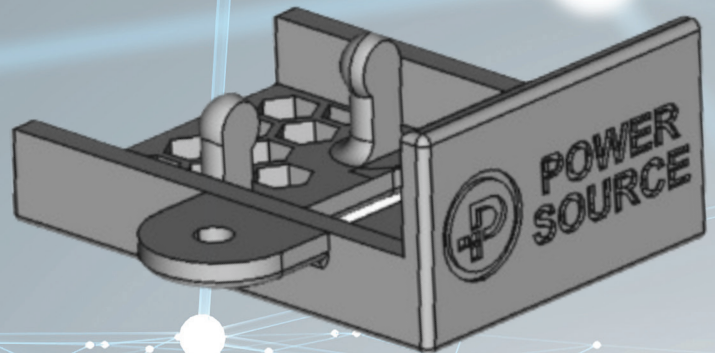

2 x Exit points for wiring

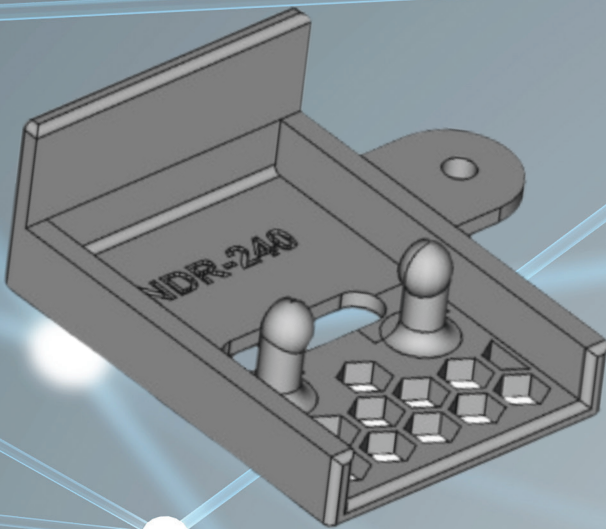
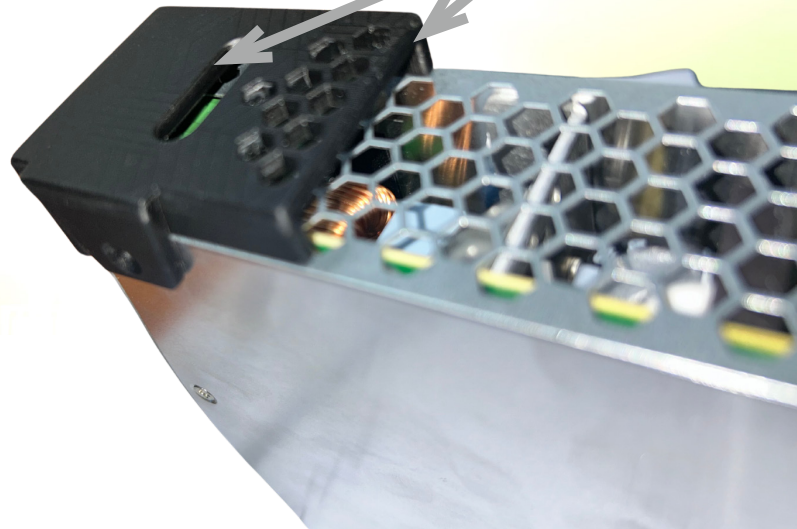
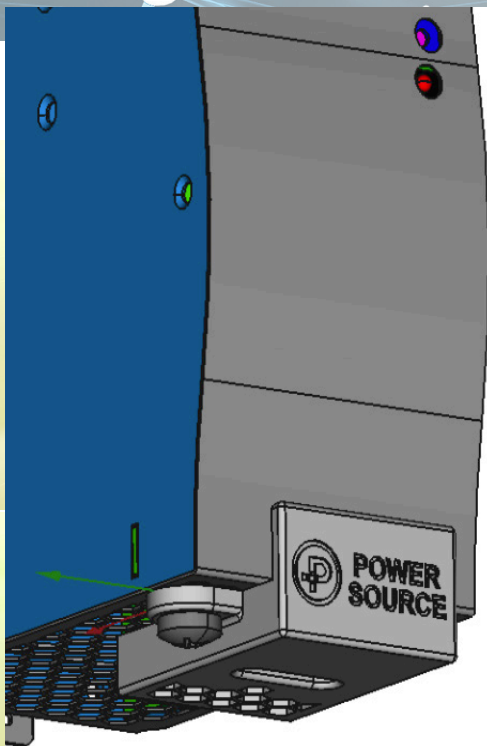

Snap on design*
Terminal labels remain visible

*Screw included