

# CRYSTAL HE PLUS LED MODULES



## Features

- Powered by high output 2835.
- Light efficacy more than 150LM/W.
- Constant voltage, CC optional.
- No Polarity limit input for CC and CV.
- Dimmable
- Integrated transparent 170°optic lens.
- 50/20 pcs per string.
- CE, ROHS, UL, TUV, BIS, CB and LM-80 certified.

## Application

- Apply to 6–20 cm depth illuminated letter or light box at airports, metros, banks, buildings and shopping malls, etc.

## Parameters

Items	Parameters			
Part Number	ZE02QC5	ZE02QD5	ZE04QC5	ZE04QD5
CCT (K)	7000K	7000K	7000K	7000K
Beaming Angle (°)	170°	170°	170°	170°
CRI (Ra)	≥70	≥70	≥70	≥70
Luminous Flux (lm)	100	100	200	200
Voltage (V)	DC24	DC24	DC24	DC24
Power (W)	0.66	0.66	1.32	1.32
Driving Method	Constant Voltage	Constant Current	Constant Voltage	Constant Current
Dimension (mm)	56*17*10.6	56*17*10.6	108*17*10.6	108*17*10.6
Working Tem. (°C)	-25 ~ +60	-25 ~ +60	-25 ~ +60	-25 ~ +60
Storage Tem. (°C)	-25 ~ +70	-25 ~ +70	-25 ~ +70	-25 ~ +70
Protection Grade	IP66	IP66	IP66	IP66

## Dimension

Unit: mm

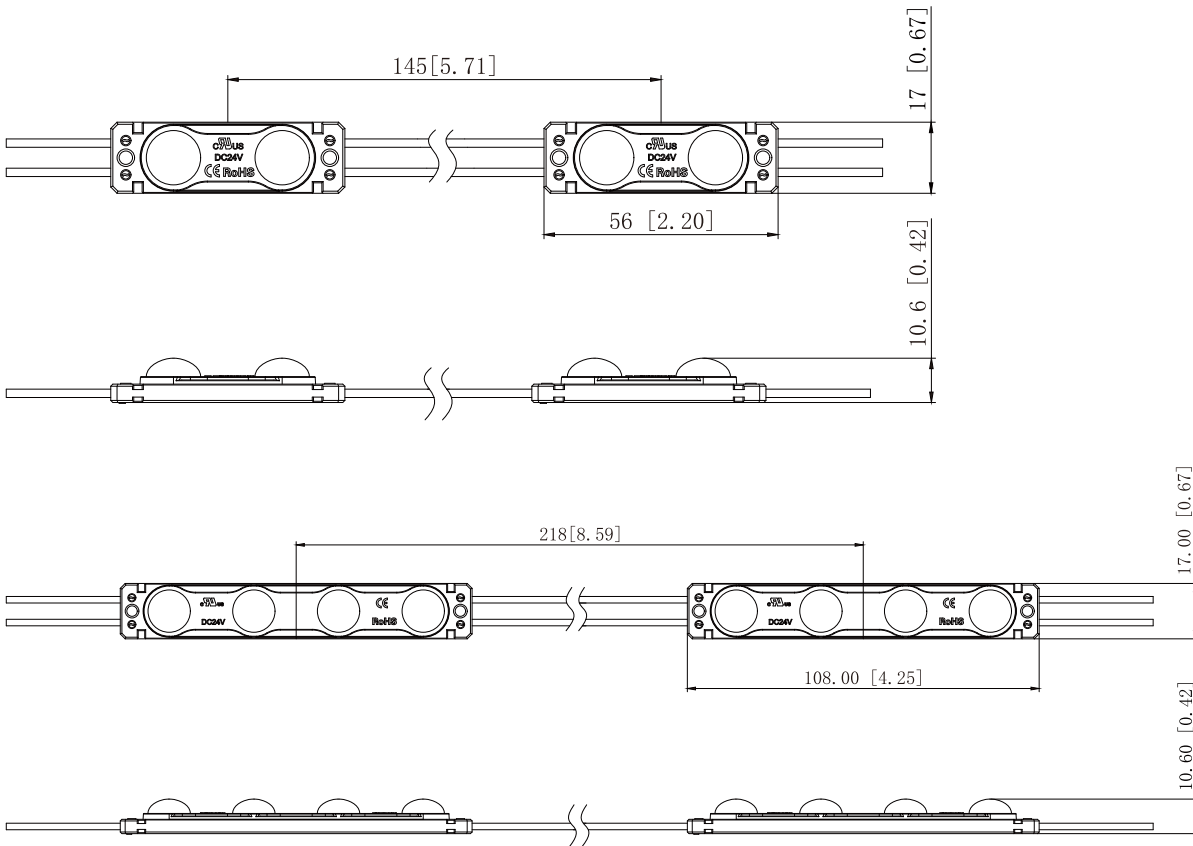

## Beaming Angle

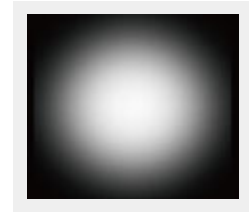
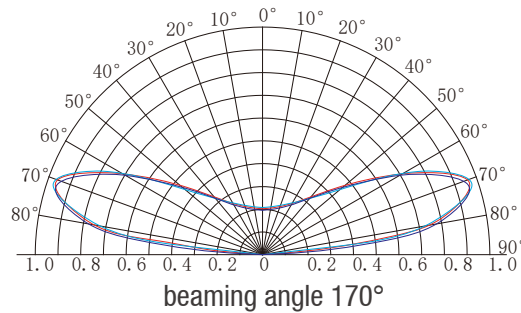

## Reference Scheme

Part Number	Depth(mm)	Distance(mm)	Density(pcs/m <sup>2</sup> )	Illumination(lux)	Illumination Effect
ZE02QC5 / ZE02QD5	Dz=60	Dx=50 Dy=90	222	4368	Uniform illumination
	Dz=80	Dx=55 Dy=95	191	3883	Uniform illumination
	Dz=100	Dx=55 Dy=95	191	3311	Uniform illumination
	Dz=120	Dx=55 Dy=95	191	2632	Uniform illumination
	Dz=140	Dx=55 Dy=95	191	2211	Uniform illumination
	Dz=160	Dx=55 Dy=95	191	2004	Uniform illumination

Part Number	Depth(mm)	Distance(mm)	Density(pcs/m <sup>2</sup> )	Illumination(lux)	Illumination Effect
ZE04QC5 / ZE04QD5	Dz=60	Dx=55 Dy=125	145	6199	Uniform illumination
	Dz=80	Dx=70 Dy=140	102	5075	Uniform illumination
	Dz=100	Dx=70 Dy=140	102	4381	Uniform illumination
	Dz=120	Dx=70 Dy=140	102	3711	Uniform illumination
	Dz=140	Dx=70 Dy=140	102	3060	Uniform illumination
	Dz=160	Dx=70 Dy=140	102	2606	Uniform illumination
	Dz=180	Dx=70 Dy=140	102	2370	Uniform illumination
	Dz=200	Dx=70 Dy=140	102	2051	Uniform illumination

### Remark :

01. Light transmittance of light box cloth was 28%, Light transmittance of light box sheet was 56%, Light transmittance of acrylic white plate was 54.4%.
02. The illumination in this example is the illuminance value under the uniform condition in the table below for this thickness.
03. The above data is for reference only.

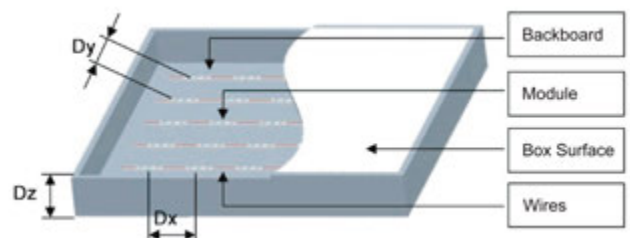

## Wire Connection

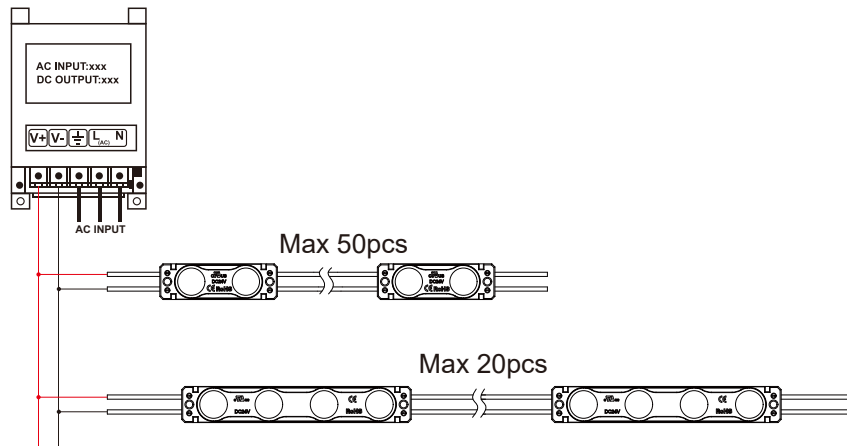

## Packing

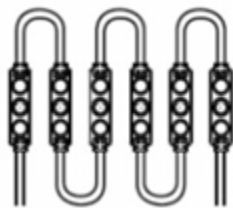

LED Module: 50/20pcs per string

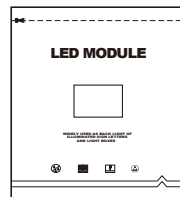

Wrapped with anti-static bag

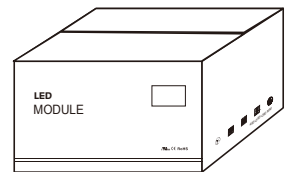

Packed in a carton

## Packing Specification

- Antistatic bag adopted
- Packing information

Part Number	ZE02QC5 / ZE02QD5	ZE04QC5 / ZE04QD5
Carton Dimension(mm)	490*450*220	490*450*220
Bag Dimension(mm)	250*460	250*460
Bags Per Carton	7	10
Quantity Per Pag(pcs)	150	100
Quantity Per Carton(pcs)	1050	1000
Net Weight(kg)	11.5(1±10%)	20(1±10%)
Gross Weight(kg)	12.5(1±10%)	20.95(1±10%)

Due to the packing manner difference, please adhere to the original products in case of discrepancy found between the picture and actual product.

## Self-provided tools & material

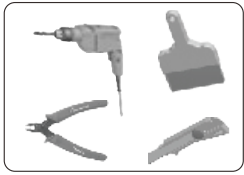

Dust brush, cutter, pencil, wire stripper, and drill



Wire Connector ( Standard)

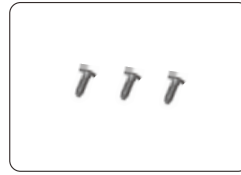

Screw

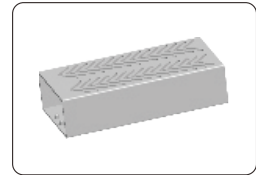

Power Supply

## Installation Guidance



- Clean inside the light box.

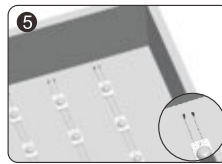

- Strip the end wire for 10mm and cap with the wire connector. Waterproof and anti-corrosion must be done on the connectors.

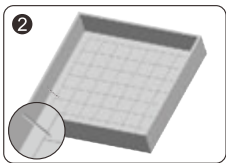

- Determine the appropriate layout.

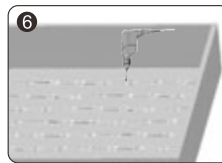

- Locate modules in the optimal position and secure with screws or neutral glass cement, which should be applied at the edge of the modules.

⚠ Note: Avoid breaking the module and wire when fixing with a drill.

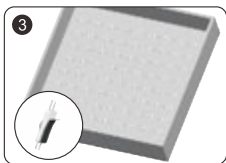

- Peel tape backing and stick modules into place.

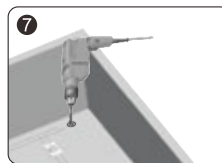

- Drill a hole for connecting power cable. Fixation and protection for the cable must be done on the hole.

⚠ Note: Avoid breaking the light box in drilling the hole.



- Remove the unneeded modules.
- ⚠ Note: Cut in the middle position of the wires between modules.

## Instructions

01. Disassembling or modifying the product is not allowed.
02. Installation with power on is not allowed.
03. Any organic solvent chemical is not allowed.
04. Acidic or alkaline adhesive is not allowed. when install, neutral glass cement could be used for installation purpose, make it drying in open environment for four hours.
05. Isolation and corrosion prevention on all wiring points and wire ends.
06. Make sure the power wire is thick enough and ensure the voltage and connections are connected correctly before power on.
07. This product should be used in a sign, do not expose it in opening site.
08. Installation, maintaining should be done by professional staff.
09. ZE02QC5/ZE02QD5 50pcs in a serial connection maximum; ZE04QC5/ZE04QD5 20pcs in a serial connection maximum.
10. The power wire between power supply and module should be less than two meters to keep the same brightness on all parts.
11. Initial location with 3M tape, then secure with screws.

## Declaration

01. Warranty: 5 years.
02. In order to ensure the safety, the broken wires need to be replaced by the manufacturer or the service agent, or by the staff with the similar qualification.
03. The given data in the specification was based on the laboratory testing, there may be discrepancy found in the actual products.
04. The given drawings in the specification are only for reference, there may be discrepancy found in the actual products.
05. The products are subject to change without prior notification.



## SHENZHEN LINGBENYANG IND. CO., LTD.

Tel: +86-755-83544570      E-mail: info@lbyled.com      Http://: www.lbyled.com  
Company Address.: 28F, Luban Building, Hongli West Road, Futian District, Shenzhen 518034, China  
Factory Address: 3F, 4F and 6F, Buiding A&B Xinyongfeng Industrial Area, Yingrenshi Village,  
Shiyan Town, Bao'an District, Shenzhen 518108, China