

# SELF-ASSEMBLING LED FLEX NEON WITH SOLDERLESS LEAD CAP

Model: SE120JC3-H1616



## Features

- 1) Glue free solderless end cap, unique crystal construction, IP67 rated.
- 2) Extremely easy to install, wide flexibility for DIY assembling.
- 3) High polymer material used, free from chemical qualifications.
- 4) Additional anti-dust process applied, delicate hand feeling.
- 5) 3 years warranty.

## Application

Home decorative lighting, landscape lighting, city lighting, the places that need linear lighting effect etc.

## Parameters

Part Number	SE120JC3-H1616	CRI	Color	CCT(K)	Beaming Angle	Luminous Flux (LM/M)	Efficacy (LM/W)
Dimensions	5000*16*16mm	80+	WW	2700	≥120°	480	50
LED Qty/m	120LEDs/m		WW	3000	≥120°	480	50
Voltage	DC24V		NW	4000	≥120°	556	58
Input Current (A)	0.4A (1m)		MW	5000	≥120°	528	55
Power	9.6W/M		W	6500	≥120°	528	55
Power Range	8.6~10.5W						
Times of Power On and Off	>10000 Times						
IP Grade	IP67						

### Remarks:

- 1) The given data are typical values due to the tolerance of the production and electrical components, output value and electrical power can vary up to 10%.
- 2) Testing standards refer to IES LM-79-08.
- 3) The above luminous flux is based on CRI80, and the number will reduce by around 20% in CRI 90.

## Dimension

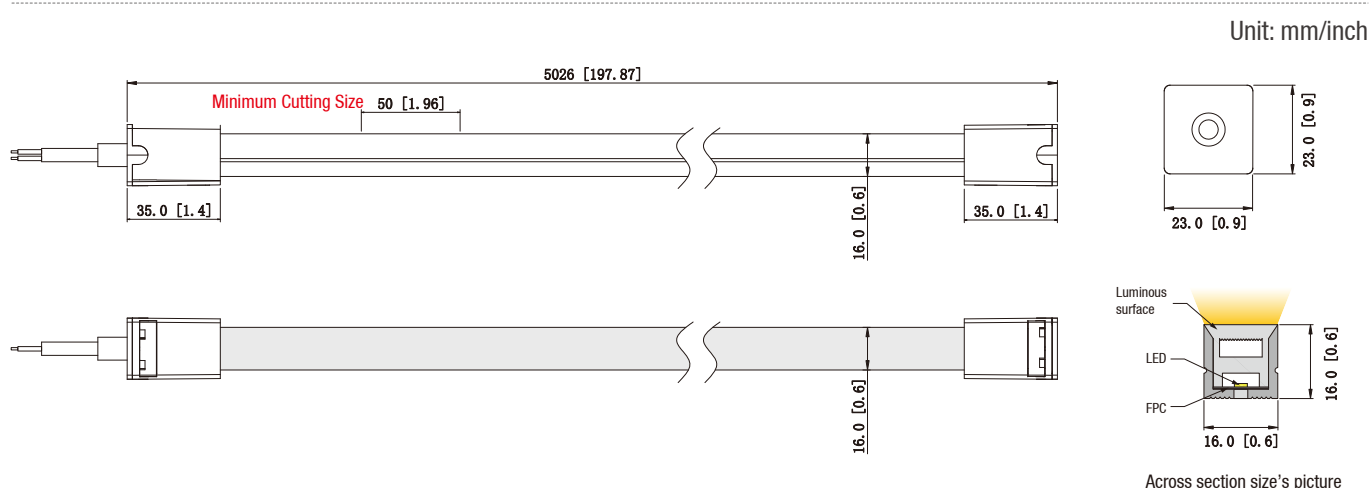

## Rendering Index Comparison

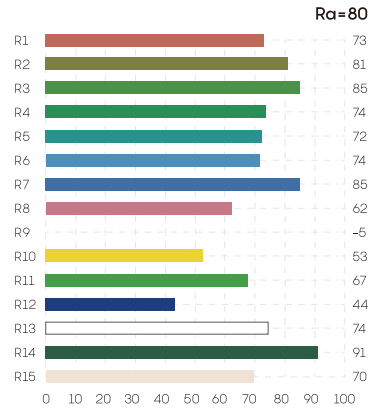
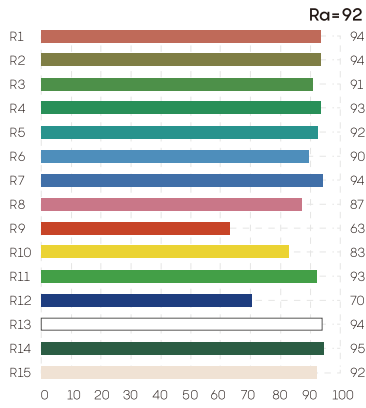

## Provide Full CCT Range From 2700K to 6500K

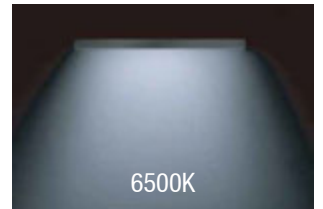
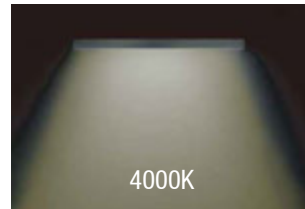
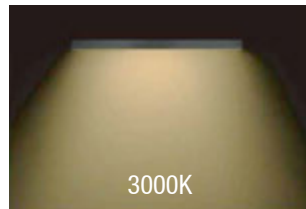

## Beaming Angle

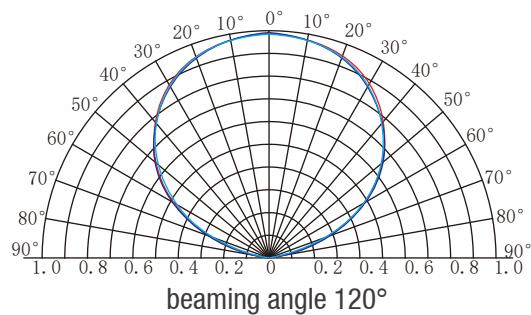

## Coordinates and Tolerances Conform to CIE 1931

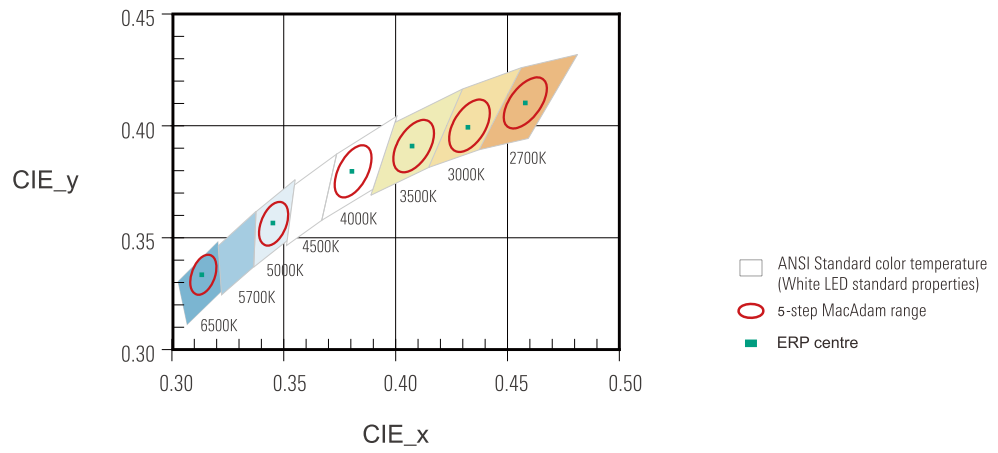

	2700K	3000K	3500K	4000K	5000K	6500K
x0	0.463	0.433	0.408	0.380	0.346	0.313
y0	0.420	0.403	0.393	0.380	0.359	0.337

## Wire Connection

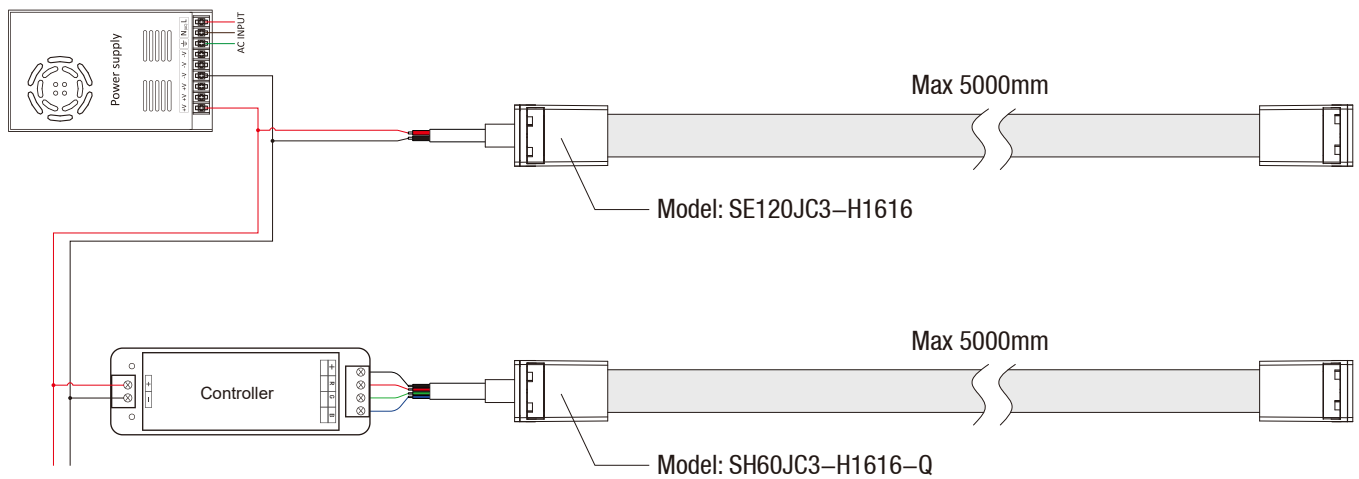

## Product Schematic

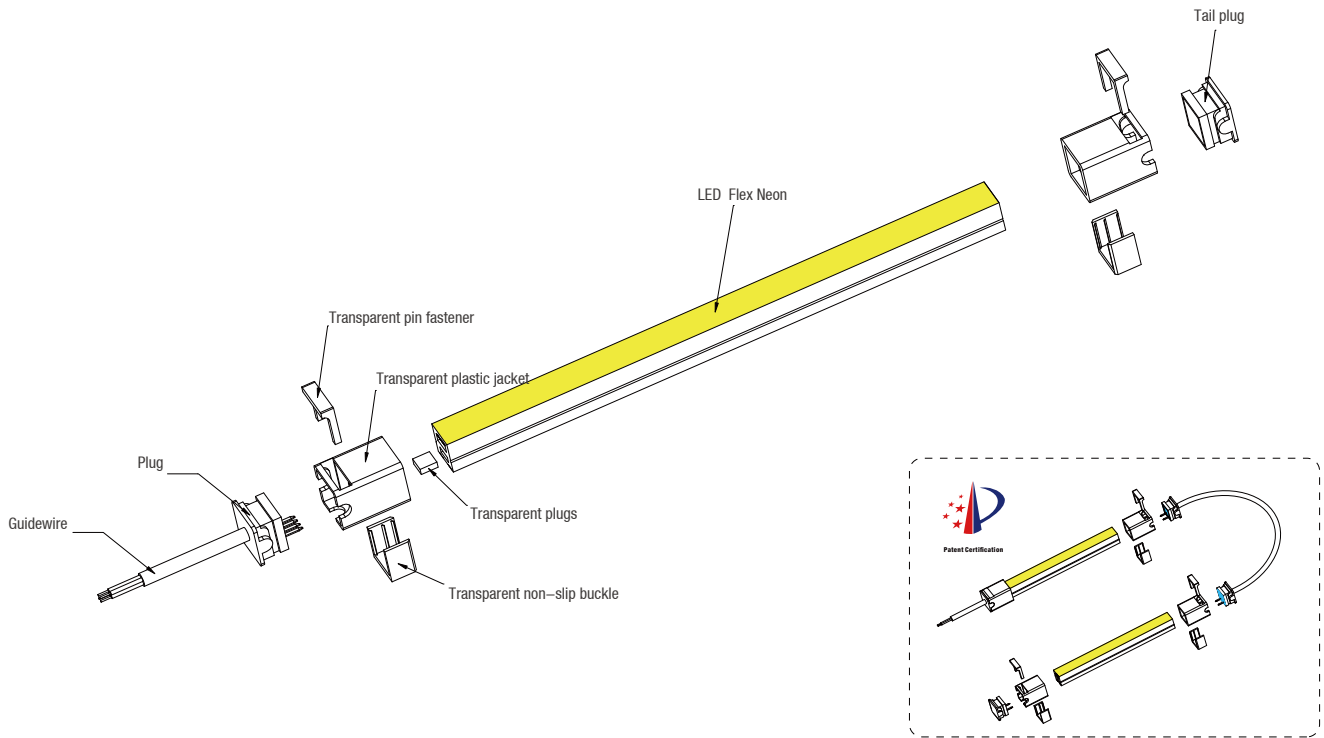

## Various Line-Out Scenarios

Three types of outlet cables are used to meet different installation requirements.



Straight Out Wire ( Top )



Side Exit Wires





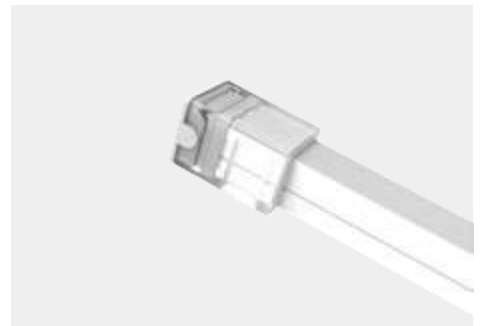





Bottom Outlet Wire



Plug (No Wire Out)

## Mounting Accessories

Accessory Name	Accessory Number	Description	Picture
2P Straight Out End Cap	4009990-008	Transparent	
2P Side Outlet End Cap	/	Transparent	
2P Bottom Outlet End Cap	/	Transparent	
Tail Cap	4009990-009	Transparent	
2P Linear Connectors	4009990-010	Transparent	
Aluminum Snap	4301460-028	Aluminum Oxide	
Aluminum Profile	4971460-013	Aluminum Oxide	
Curved-Profile	4181290-001	Stainless Steels	

## Packing information

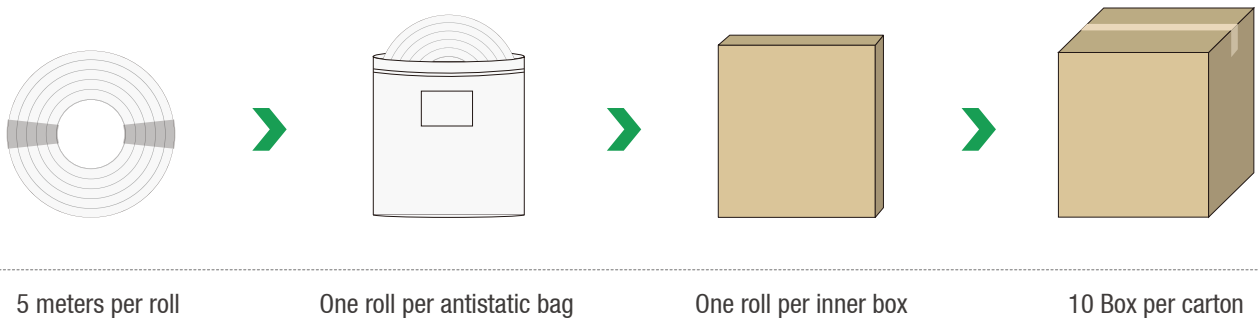

Part Number	Outer Box Dimension (mm)	Inner Box Dimension (mm)	Quantity Per Carton (m)	Net Weight (kg)	Gross Weight (kg)
SE120JC3-H1616	L425*W425H390	L410*W410*H35	50	14.3	17.5

Given the packing manner difference, the actual packing information is subject to that for the real products.

## Bending Direction

Please note when installing the strip, not all directions can be bent, bending shape, bending diameter size and direction, please follow the legend below to avoid damage to the LED strip.

### Correct Way to Bend

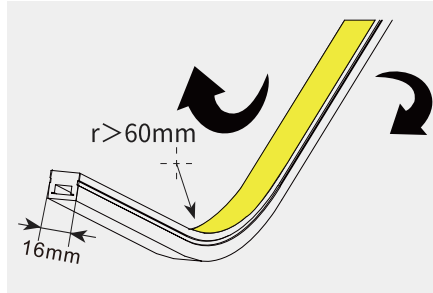
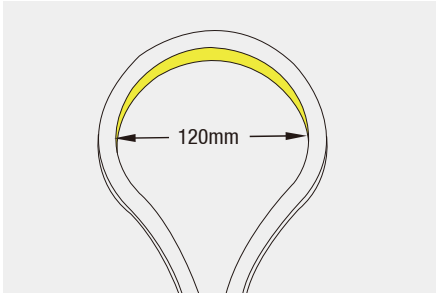

### Wrong Way to Bend

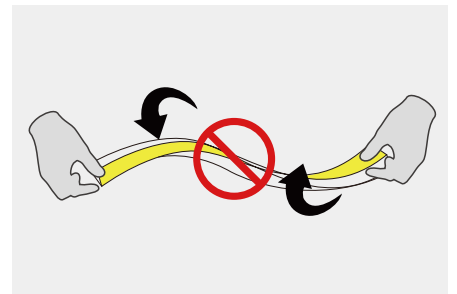
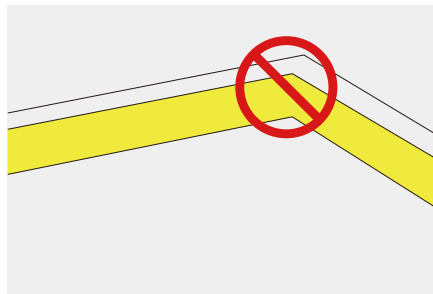
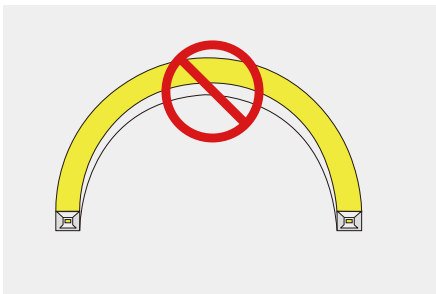

## Cutting mark

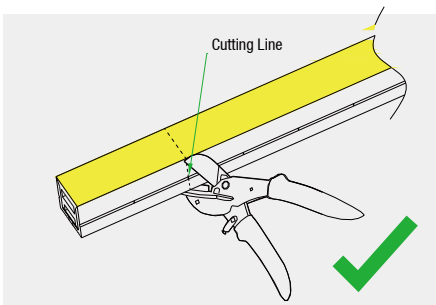

There are many black cutting marks on the back of each LED neon, please use a professional cutting tool to cut vertically at the exact cutting position.

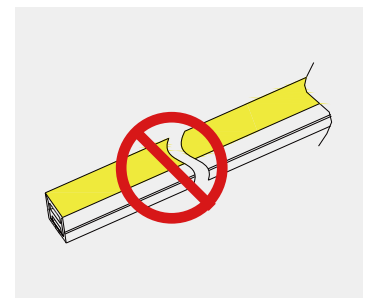
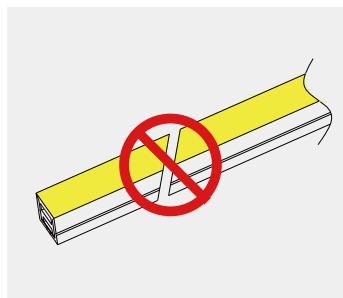

 Please don't cut at an angle or in an S-shape.

## Accessory Installation Procedure

### End Cap Mounting

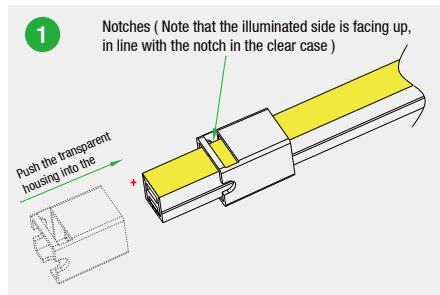

Thread the positive end of the LED neon into the transparent housing (note the positive direction).

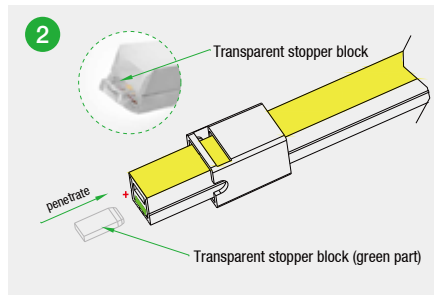

Thread the Transparent stopper block into the LED neon tape flush with the cut.

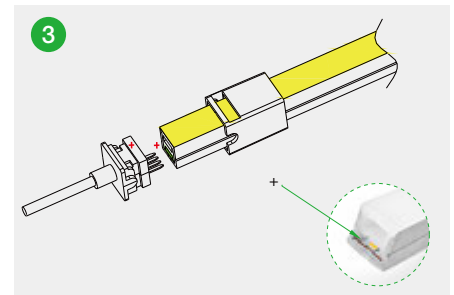

Note that the positive pole of the copper pin and the positive pole of the LED neon should be in the same direction.

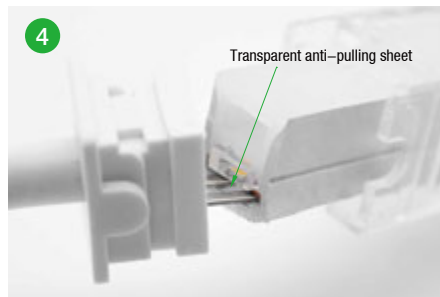

Pull apart the flexible board of the LED strip and the transparent anti-pulling sheet, insert the copper pin of the end cap into the bottom of LED strip flexible board. Note that the copper pin must not be inserted into the bottom of the transparent pull-resistant piece, otherwise the copper pin will not make contact with the soldering pad at the bottom of the flexible board, resulting in non-conductive operation.

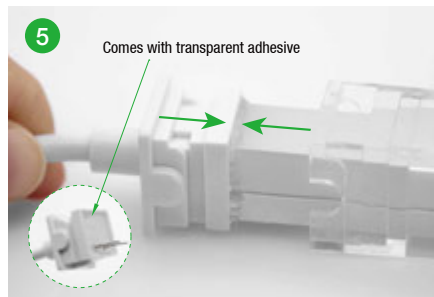

Put the neon LED neon into the frame of the End cap and let the transparent adhesive around the LED neon.

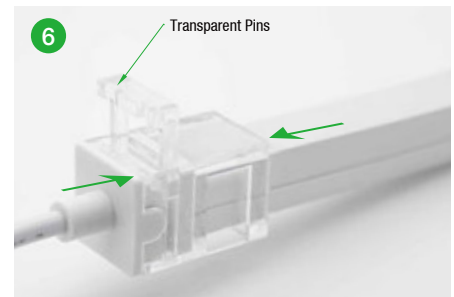

Snap on the transparent housing, Press end cap and the transparent housing firmly together and insert the transparent pin into the transparent housing.

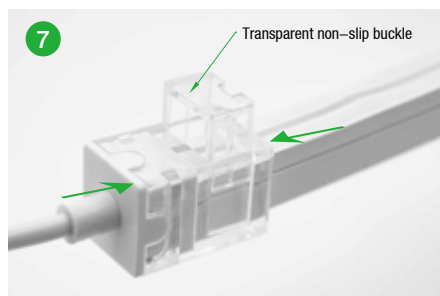

Press the transparent housing and the LED neon firmly, then insert the transparent non-slip buckle into the transparent housing.

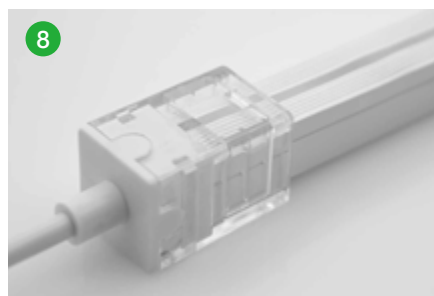

Installation completed effect.



### Tail Cap Mounting

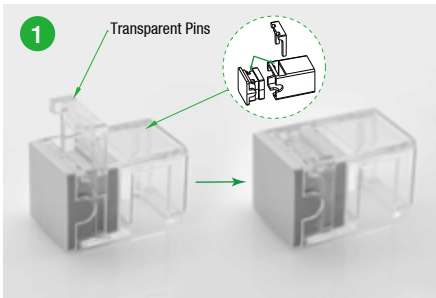

Press the end cap and clear housing combination firmly together and insert the clear pin.

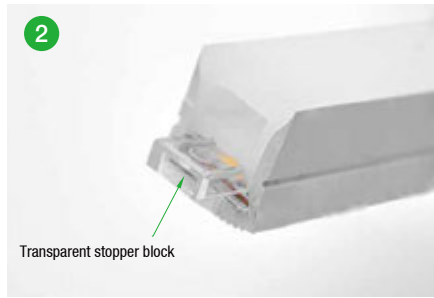

Thread the Transparent stopper block into the LED strip tape flush with the cut.

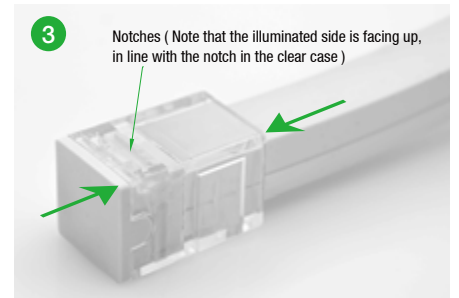

Put the LED neon into the frame of the End cap and let the clear adhesive tape wrap around the LED neon.

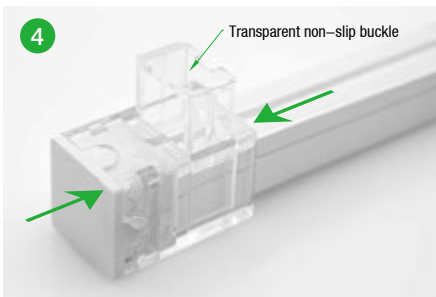

Press the transparent housing and the LED neon firmly, then insert the transparent non-slip buckle into the transparent housing.

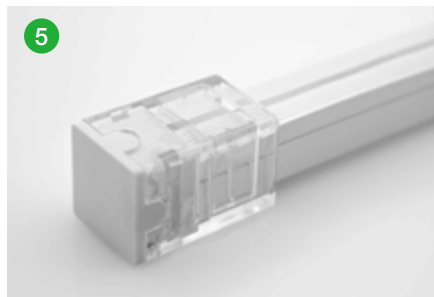

Installation completed effect.

## Instructions

- 01) Disassembling or modifying the product is not allowed.
- 02) Installation with power on is not allowed.
- 03) Any organic solvent chemical is not allowed.
- 04) Isolation and corrosion prevention on all wiring points and wire ends.
- 05) Make sure the power wire is big enough and ensure the voltage and connection are all correct before power on.
- 06) Installation, maintenance should be done by professional staff.
- 07) The power wire between power supply and LED strips should be less than two meters to keep the same brightness on all parts.
- 08) Do not power on during installation or assembly of the light strip, to avoid short-circuiting and burning out of the light strip due to misoperation during the operation
- 09) The lamp beads can only be powered on when they are connected, installed and correct.
- 10) When installing, try to avoid excessive bending and twisting of the light strip, so as not to damage the conductive components and cause defects.
- 11) The LED flexible light strip can only be cut at the place where the cut mark is printed on the light strip. Cutting at other places will damage the circuit circuit of the light strip and cause some lamp beads to not light up.
- 12) The maximum bending diameter of this product: >120mm.

## Declaration

- 01) To ensure the safety, the broken wires need to be replaced by the manufacturer or the service agent, or by the qualified staff.
- 02) The given data in the specification is the laboratory data, there may be discrepancy found in the actual products.
- 03) The given drawings in the specification are only for reference, there may be discrepancy found in the actual products.
- 04) The products are subject to change without prior notification.



Official Website



WeChat Public

## SHENZHEN LEADBEYOND LINEAR LIGHTING CO., LTD.

Tel: +86-755-83056231    info@leadbeyondled.com    www.leadbeyondled.net    www.leadbeyondled.com

Company Address.: 28F, Luban Building, Hongli West Road, Futian District, Shenzhen 518034, China

Factory Address: 3F, 4F and 6F, Buiding A&B Xinyongfeng Industrial Area, Yingrenshi Village, Shiyan Town, Bao'an District, Shenzhen 518108, China