

SensorDIM™ - Integrated HF Sensor and LED Driver

HEC7030

Detached Version with Daylight Monitoring and Photocell Advance™

HYTRONIK®

Applications

Occupancy sensor and constant current LED driver, 2-in-1.

Suitable for building into the fixture for:

- Office / Commercial Lighting
- Classroom
- Meeting Room

Use for retrofit and new luminaire designs/installations



Features

- 24 hour daylight monitoring dawn/dusk sensor
- Special photocell to measure and differentiate natural light from LED light from behind the fixture cover
- One-touch daylight learning via remote control
- Tri-level dimming control based upon occupancy (also known as corridor function)
- Easy-on-the-eye operation which makes the light turning on/off less uncomfortable
- DIP switch offers multiple current selections for different luminaire requirements
- 5 Year, 50,000hr Warranty

Technical Data

Input Characteristics

Model No.	HEC7030
Mains voltage	220~240VAC 50/60Hz
Input current	0.17 - 0.16A
Input power	35W
Warming-up	20s

Driver Data

Empty load voltage	70V
Power factor	≥0.9
Efficiency	85% (Max.)
Output current	350/500/550/700/750/900mA

Safety and EMC

EMC standard (EMC)	EN55015, EN61547, EN6100-2/3
Safety standard (LVD)	EN61347-1, EN61347-2-13
Dielectric strength	Input→output: 3750VAC / 5mA / 1min
Abnormal protection	Output short-circuit protection
Certification	Semko, CB, CE, EMC, RED, SAA

Sensor Data

Model No.	HEC7030
Sensor principle	High Frequency (microwave)
Operation frequency	5.8GHz +/- 75MHz
Transmission power	<0.2mW
Detection range	Max. (Ø x H) 8m x 5m
Detection angle	30° ~ 150°
Setting adjustments:	
Sensitivity	Sensor OFF / 50% / 75% / 100%
Hold time	5s ~ 10min (selectable)
Daylight threshold	5 ~ 50 lux, disabled
Stand-by period	0s / 10s / 30min / +∞
Stand-by dimming level	10% / 30%

Environment

Operation temperature	Ta: -20°C ~ +50°C
Case temperature (Max.)	Tc: +75°C
IP rating	IP20

CE emc RED SAA CB IP20

Main Body

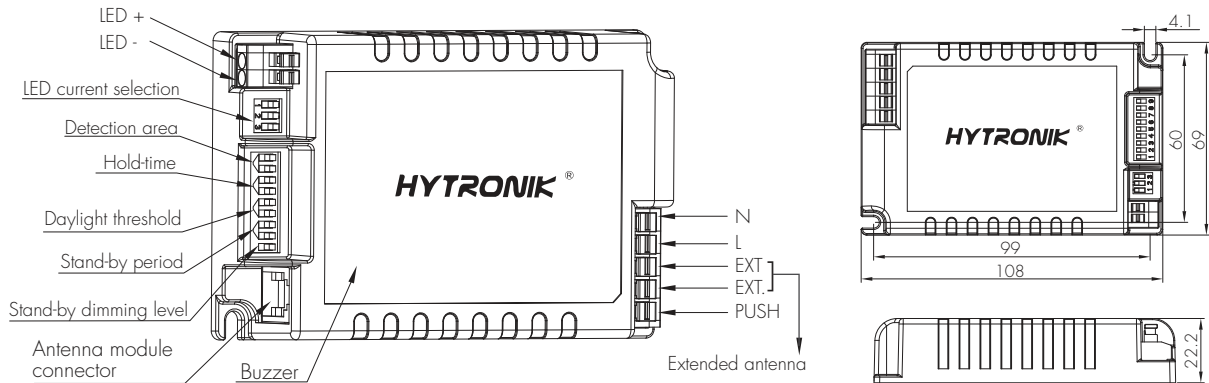

With the **detached sensor antenna SAM5**, it requires very little space on the LED panel. Only the antenna is installed on the PCB surface, while the main body can be hidden behind the panel. Completely shadow free.

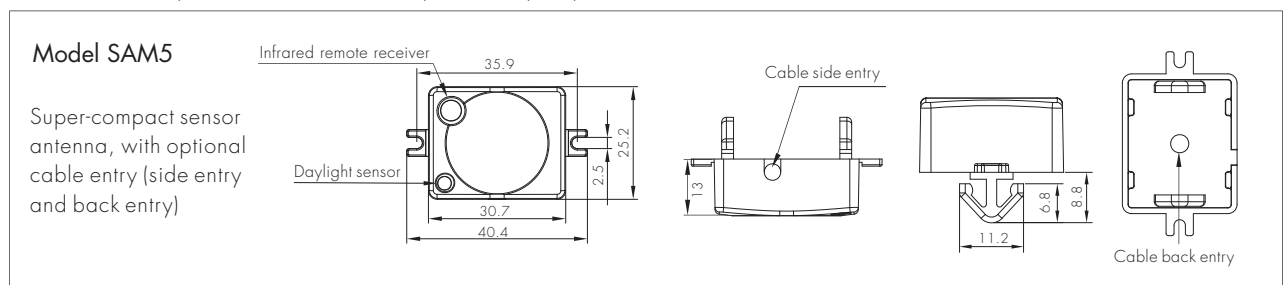

2 in 1 and cost effective! This is a smart integration of microwave motion sensor and multiple current selection LED driver, which gives pre-selected constant current to drive the LEDs to work based upon movement detection.

Sensor Functions and Features

1 Photocell Advance™ Function

It's well known that LED lights have a totally different spectrum to natural light. Hytronik uses this principle and comes up with special photocell and sophisticated software algorithm to measure and differentiate natural light from LED light from behind the fixture cover, so that this photocell can ignore internal LED light and only respond to the natural light outside. Our technology has no infringement to the existing patents in the market.

Settings on this demonstration:

Hold-time: 10min

Daylight threshold: 50lux

Stand-by dimming level: 10%

Stand-by period: +∞

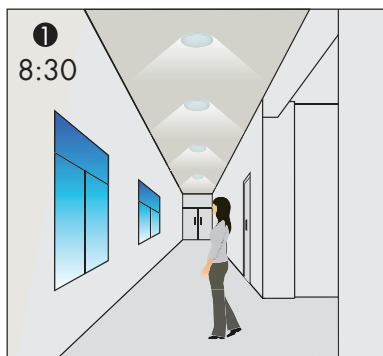

With insufficient natural light, the light switches on at 100% when there is motion detected.

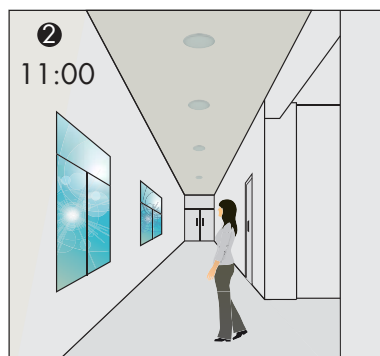

The light turns off completely whenever natural light reaches above pre-set daylight threshold, even with presence.

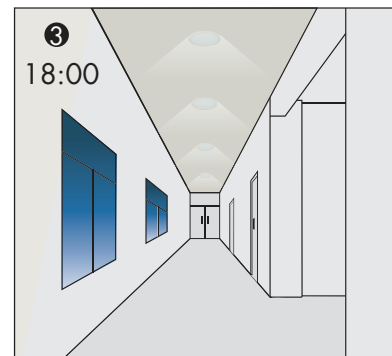

The light turns on at dim level automatically when natural light level drops below pre-set daylight threshold (no motion).

2 24h Daylight Monitoring Function

Now with Photocell Advance technology, natural daylight will override the occupancy sensor.

Automatic on/off, based upon natural daylight conditions, our innovative and patented software enables our antenna with built-in daylight sensor to provide a "smart photocell" or dawn/dusk function from behind the luminaire cover, preventing the need to drill for an external photocell. This function is activated when the stand-by period is set to "+∞".



The light switches on at 100% when there is movement detected.



The light dims to stand-by level after the hold-time.

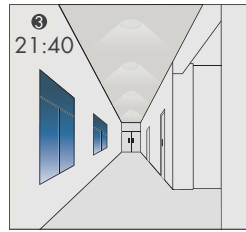

The light remains in dimming level at night.

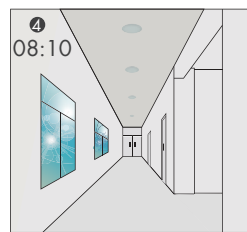
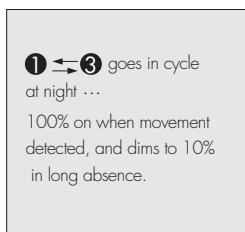

The light turns off completely when natural light reaches above daylight threshold.



The light automatically turns on at 10% when natural light is insufficient (no motion).

Settings on this demonstration:

Hold-time: 10min
Daylight threshold: 50lux
Stand-by dimming level: 10%
Stand-by period: +∞

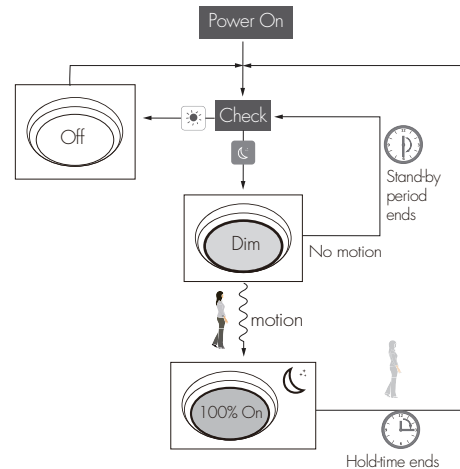

3 Master/Slave Group Control

By connecting the "EXT" terminals in parallel (maximum 10pcs, see wiring diagram), no matter which sensor detects motion, all HEC7030 in the group will turn on the lights when surrounding natural light is below daylight threshold. The detection area is greatly enlarged in this way. Other settings such as hold-time, stand-by period, stand-by dimming level and daylight threshold on each individual unit stay the same.

Note: if the surrounding natural light of the sensor which detects movement is sufficient, all lights in the group will not be triggered on.

4 Semi-auto Mode (Absence Detection)

In many other cases, people do not want to have a sensor to switch on the light automatically, for example, when people is just passing by, there is no need to have the light on.

The solution is to apply 'Semi-auto mode (absence detection)': by pressing the "M/A" button on the remote control and manual initiation on the push-switch, the motion sensor remains active, turns on and dims the light automatically, and eventually switches it off in absence.

This is a good combination of sensor automation and manual override control, to have the maximum energy saving, and at the same time, to keep efficient and comfortable lighting.

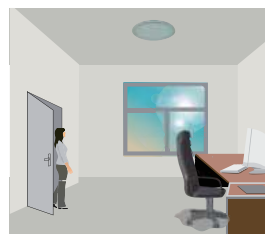

Light does not switch on when presence detected.



Short push to activate the sensor and switch on the light.

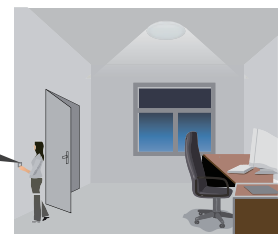

The light turns on full, and the sensor stays in sensor mode.

5 Manual Override

This sensor reserves the access of manual override function for end-user to switch on/off, or adjust the brightness by push-switch, which makes the product more user-friendly and offers more options to fit some extra-ordinary demands:

* Short Push (<1s): on/off function;

On → Off: the light turns off immediately and cannot be triggered ON by motion until the expiration of pre-set hold-time. After this period, the sensor goes back to normal sensor mode.

Off → On: the light turns on and goes to sensor mode, no matter if ambient Lux level exceeds the daylight threshold or not.

* Long Push (>1s): adjust the hold-time brightness level.

Note: 1. if end-user do not want this manual override function, just leave the "push" terminal unconnected to any wire.

2. if the detection area is set at "Sensor OFF", HEC7030 becomes a regular dimmable LED driver which can be dimmed (1% ~ 100%) by push-switch.

3. end-user can choose either function 4 or function 5 for application. Default function is manual override.

Settings (Remote Control HRC-05)

Permanent ON/OFF function

Press the "ON/OFF" button, the light goes to permanent on or permanent off mode, and the sensor is disabled.

* Press "Auto Mode", "RESET" or "Scene mode" buttons to quit this mode.

Sensor mode

Press "Auto Mode" button, the sensor starts to function and all settings remain the same as the latest status before the light is switched on/off.

Reset function

Press "RESET" button, all settings go back to default settings.

Dim +/-

Long press "Dim +" or "Dim -" to adjust the light brightness during hold-time. "+" means dimming up, "-" means dimming down.

Test mode

This button is for testing purpose only. The sensor goes to test mode (hold-time is 2s) after commissioning, meanwhile the stand-by period and daylight sensor are disabled.

* This mode can be ended by pressing "reset", or any button of "scene mode" and "hold-time". The sensor settings are changed accordingly.

Power output

By pressing these two buttons, the output shifts between 80% (at initial 10,000 hours) and 100%, for energy saving purpose.

Ambient daylight threshold

Press this button, the latest surrounding lux value overwrites the previous lux value learned, and it is set as the daylight threshold. This feature enables the fixture to function well in any real application circumstances.

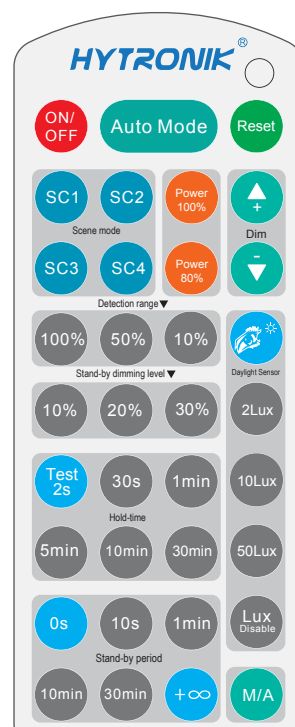

HRC-05

Note: the buzzer beeps one time when RC receives signal successfully.

Lux Disable Lux disable

Press this button, the built-in daylight sensor stops working, and all motion detected could turn on the lighting fixture, no matter how bright the natural light is.

M/A Manual override / Semi-auto mode (absence detection)

By pressing this button, the sensor goes to manual override or Semi-auto mode (absence detection) function.

* The buzzer beeps twice if it's manual override function, and beeps once if it shifts to Semi-auto mode (absence detection).

Scene mode

There are 4 scene modes fixed program built in the remote control to choose for different applications:

Scene options	Detection range	Hold-time	Stand-by period	Stand-by dimming level	Daylight sensor
SC1	100%	1min	10min	10%	2Lux
SC2	100%	5min	10min	10%	2Lux
SC3	100%	10min	30min	10%	10Lux
SC4	100%	10min	+∞	10%	50Lux

* End-user can adjust the settings by pressing buttons of detection range/hold-time/stand-by period/stand-by dimming level/daylight sensor. The last setting stays in validity.

Detection range

Press the buttons of "detection range" to set detection range at 10% / 50% / 100%.

Hold-time

Press the buttons of "hold-time" to set hold-time at 30s / 1min / 5min / 10min / 30min.

Daylight sensor

Press the buttons of "daylight sensor" to set daylight threshold at 2Lux / 10Lux / 50Lux.

Stand-by period (corridor function)

Press the buttons of "stand-by period" to set stand-by period at 0s / 10s / 1min / 10min / 30min / +∞.

* "0s" means on/off control; "+∞" means bi-level dimming control, light never switches off when daylight sensor is disabled.

Stand-by dimming level

Press the buttons of "stand-by dimming level" to set the stand-by dimming level at 10% / 20% / 30%.

Detection Pattern

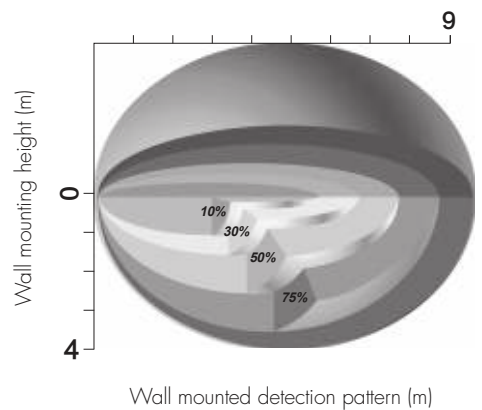
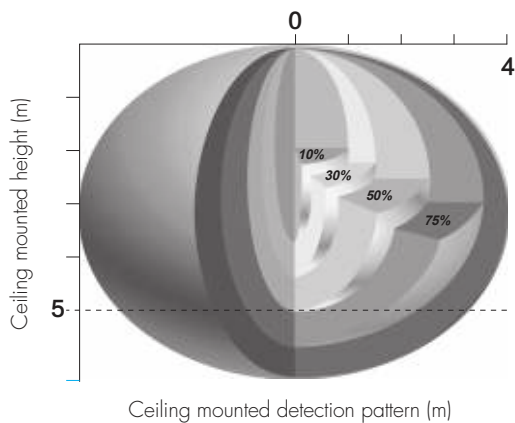

DIP Switch Settings

1 Detection Range

Sensor sensitivity can be adjusted by selecting the combination on the DIP switches to fit precisely for each specific application.

Note: by choosing "Sensor OFF", it becomes an ordinary driver without occupancy detection.

	1	2	
I	●	●	100%
II	●	○	75%
III	○	●	50%
IV	○	○	Sensor OFF



 I – 100%
 II – 75%
 III – 50%
 IV – Sensor OFF

2 Hold Time

Select the DIP switch configuration for the light on-time after presence detection. This function is disabled when natural light is sufficient.

Note: this function is disabled when the natural daylight exceeds the daylight threshold setting for more than 5minutes.

	3	4	
I	●	●	5s
II	●	○	30s
III	○	●	3min
IV	○	○	10min



 I – 5s
 II – 30s
 III – 3min
 IV – 10min

3 Daylight Threshold

Set the level according to the fixture and environment. The light will not turn on if ambient lux level exceeds the daylight threshold preset.

Please note that the ambient lux level refers to internal light reaching the sensor.

Disabling the daylight sensor will put the sensor into occupancy detection only mode.

	5	6	
I	●	●	Disable
II	●	○	50Lux
III	○	●	10Lux
IV	○	○	5Lux



 I – Disable
 II – 50Lux
 III – 10Lux
 IV – 5Lux

4 Stand-by period (corridor function)

This is the time period you would like to keep at the low light output level before it is completely switched off in the long absence of people.

Note: "0s" means on/off control;

"+∞" means the stand-by period is infinite and the light is effectively controlled by the daylight sensor, off when natural light is sufficient and automatically on at dimming level when insufficient.

	7	8	
I	●	●	0s
II	●	○	10s
III	○	●	30min
IV	○	○	+∞



 I – 0s
 II – 10s
 III – 30min
 IV – +∞

5 Stand-by dimming level

The setting is used to select the desired dimmed light level used in periods of absence for enhanced comfort and safety.

	9	
I	●	10%
II	○	30%



 I – 10%
 II – 30%

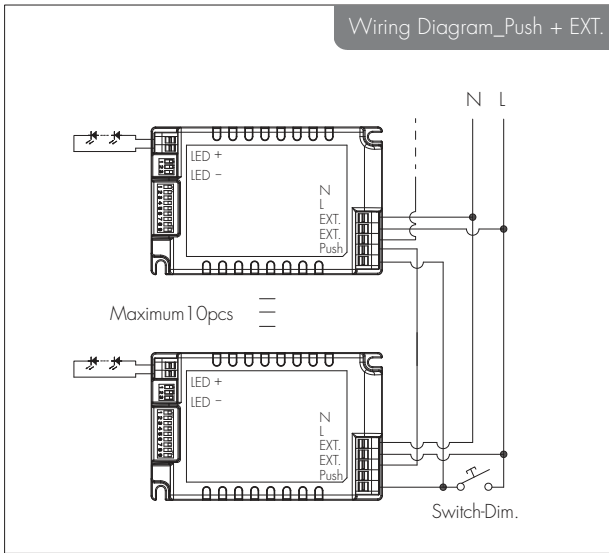
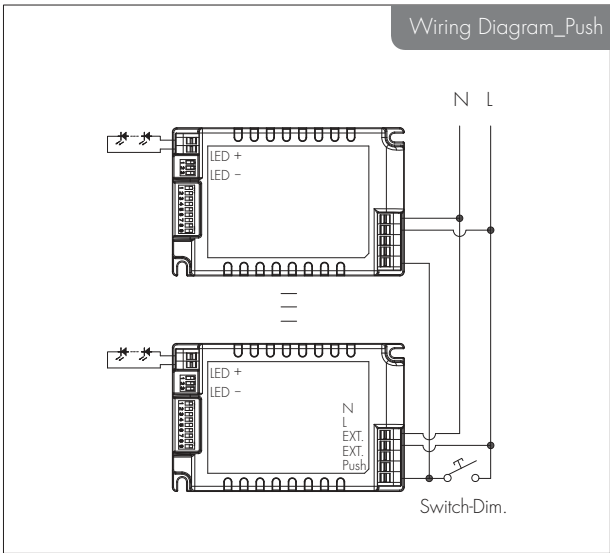

LED Driver Specification

1 LED Current Selections



I	●	●	●	900mA
II	○	●	●	750mA
III	●	●	○	700mA
IV	○	●	○	550mA
V	●	○	○	500mA
VI	○	○	○	350mA
1	2	3	Current	



The current can be easily configured by choosing the correct combination of the DIP switches (see table on the left).

2 LED Maximum Load and Voltage

This multiple current LED driver has a wide range of loading capacity:

Maximum load @ different currents:	3.5~21W (350mA)	5~30W (500mA)	5.5~30W (550mA)
	7~30W (700mA)	7~30W (750mA)	9~23W (900mA)

Maximum voltage @ different currents:	10~60V (350mA)	10~60V (500mA)	10~55V (550mA)
	10~43V (700mA)	10~40V (750mA)	10~25V (900mA)